

SINGER
81U86,U88

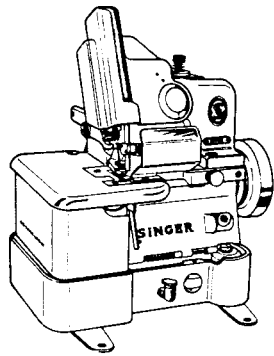

SINGER*

81U86 81U88

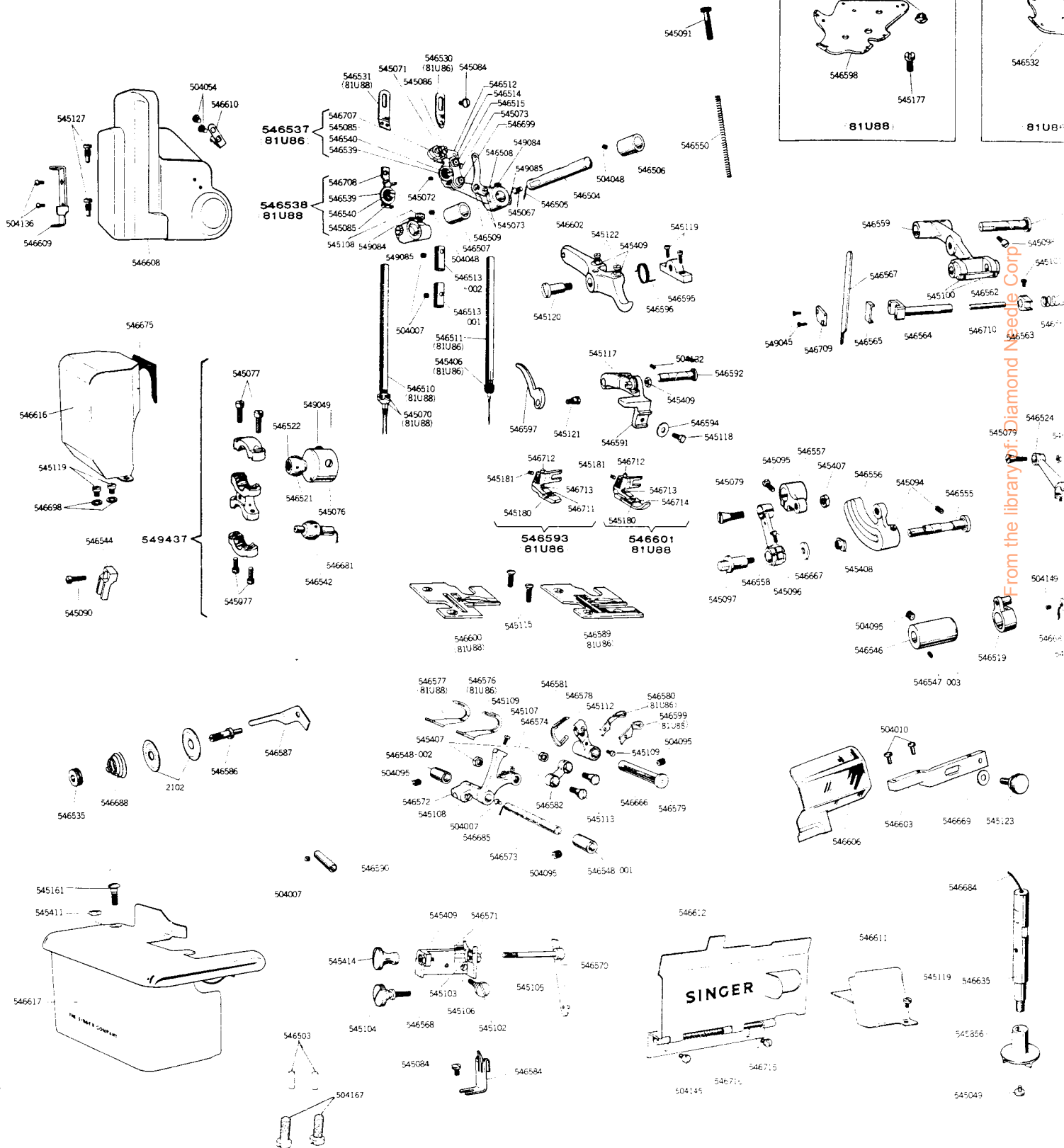

From the library of: Diamond Needle Corp.



186

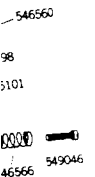

98

3101



46566

549046

149

46683

546518

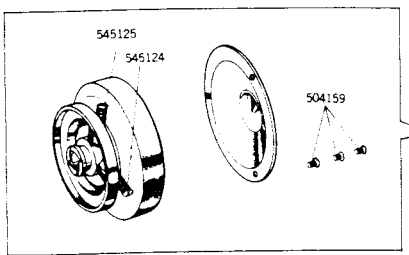
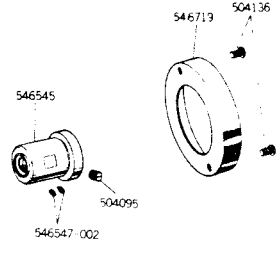
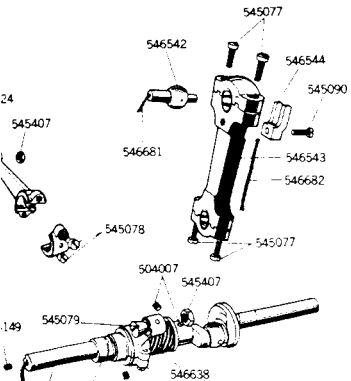
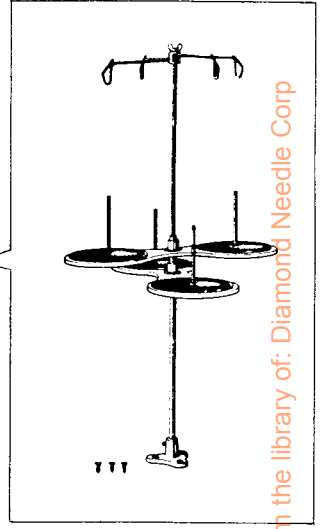
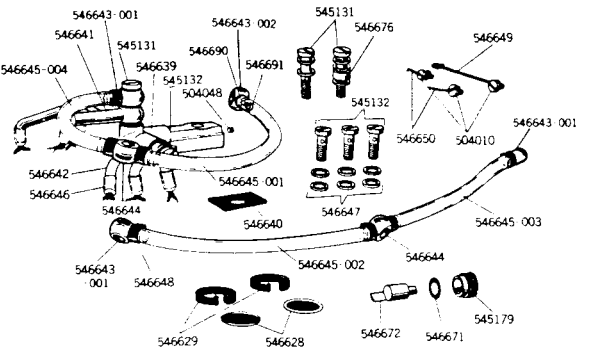
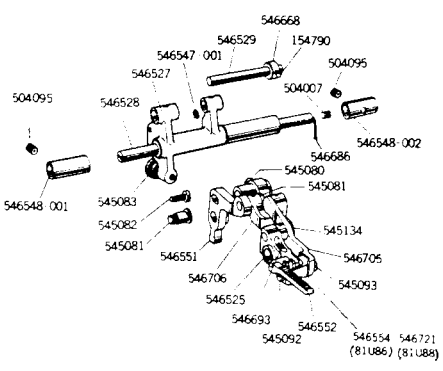
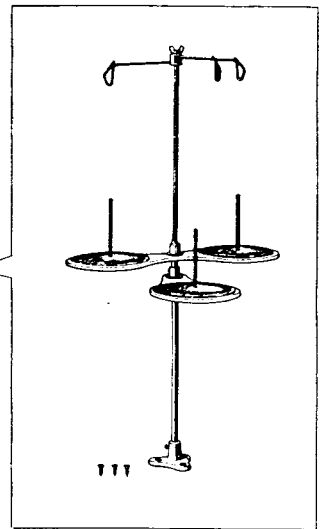
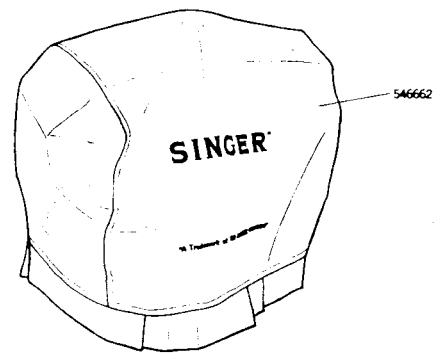
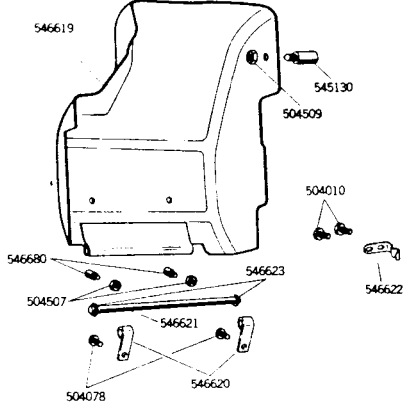

546720

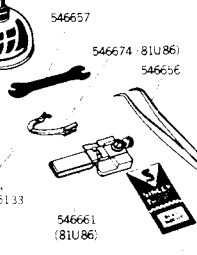
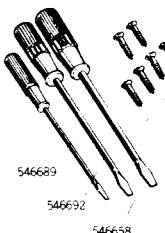
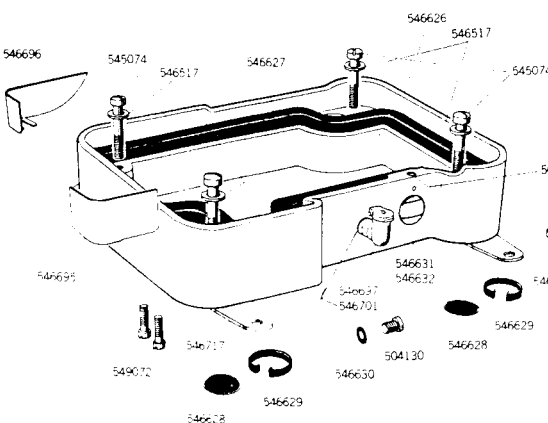
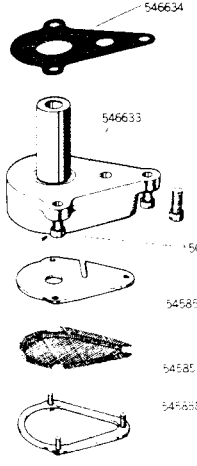
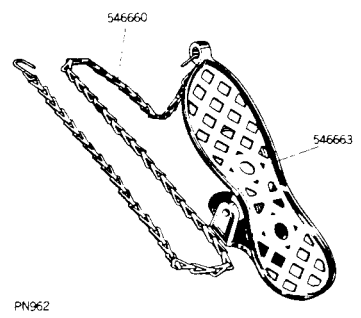
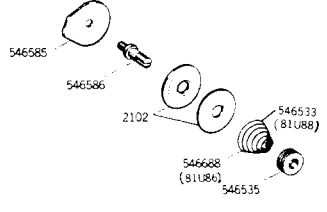
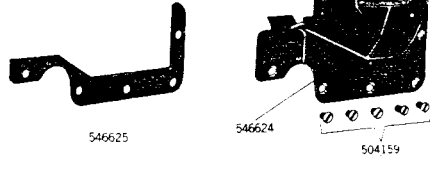

1225 (81U86)

From the library of: Diamond Needle Corp

NUMERICAL LIST OF PARTS FOR MACHINES 81U86 AND 81U88

PART NO.	DESCRIPTION	PART NO.	DESCRIPTION	PART NO.	DESCRIPTION
2102	Tension (looper, left hand) Disc (2)	504509 (809)	Frame Back Cover Thumb Screw Nut	545101 (850)	Knife (movable) Holder Guide Set Screw
2102	Tension (looper, right hand) Disc (2)	545049 (805)	Oil Pump (centrifugal) Impeller Locking Screw	545102 (850)	Knife (stationary) Holder Screw
2102	Tension (needle thread) Disc (2), for 81U86	545050 (805)	Oil Pump (centrifugal) Screen Frame Screw (3)	545103 (850)	Knife (stationary) Holder Stop Screw (2)
2102	Tension (needle thread) Disc (4), for 81U88	545067 (821)	Needle Bar Crank Shaft Plug Screw	545104 (850)	Knife (stationary) Holder Regulating Thumb Screw
154790 (852)	Feed (front) Bar Hinge Pin Collar Set Screw	545070 (830)	Needle Set Screw (2), for 81U88	545105 (850)	Knife (stationary) Clamping Stud
504007 (850)	Feed (front) Eccentric Set Screw (2)	545071 (853)	Needle Bar Connecting Bracket Clamping Screw	545106 (850)	Needle Guard Screw
504007 (850)	Feed (front) Rock Shaft Hinge Pin Plug Screw	545072 (833)	Needle Bar Connecting Link Hinge Pin Set Screw	545107 (853)	Thread (looper, left hand) Eyelet Screw
504007 (850)	Looper (right hand) and Spreader Lever Hinge Pin Plug Screw	545073 (853)	Needle Bar Connecting Link Hinge Pin Set Screw	545108 (833)	Looper (right hand) and Spreader Lever Ball Stud Set Screw
504007 (850)	Needle Bar Bushing (lower) Set Screw	545073 (853)	Thread (needle) Take-up Screw (2)	545108 (833)	Needle Bar Crank (back) Ball Stud Set Screw
504007 (850)	Needle Bar Bushing (upper) Set Screw	545074 (805)	Frame Screw (4)	545109 (853)	Thread (looper, right hand) Take-up Screw
504007 (850)	Oil Pump (centrifugal) Impeller Shaft Gear Set Screw (2)	545076 (833)	Frame Rotary Shaft Crank Position Screw	545109 (853)	Looper (right hand) Screw
504007 (850)	Thread (looper, left hand) Tube Set Screw	545077 (850)	Looper (right hand) and Spreader Lever Connection Cap Screw (4)	545112 (810)	Looper (left hand) Clamping Screw
504010 (829)	Chip Guard Screw (2)	545077 (850)	Needle Bar Connecting Rod Cap Screw (4)	545113 (850)	Looper (left hand) Lever Connecting Link Hinge Screw (2)
504010 (829)	Frame Back Cover Lock Spring Screw (2)	545078 (803)	Feed (front) Connecting Rod Cap Screw (2)	545115 (829)	Throat Plate Screw (2)
504010 (829)	Oil Tube Holder Screw (3)	545079 (850)	Feed (front) Connecting Rod Hinge Screw	545117 (853)	Presser Lever Screw Stud (eccentric)
504048 (833)	Feed (front) Lifting Eccentric Set Screw (2)	545079 (850)	Feed (front) Regulator Connection Hinge Screw	545118 (853)	Presser Foot Screw
504048 (833)	Needle Bar Crank Shaft Bushing (back) Set Screw	545079 (850)	Knife (movable) Lever Connection Hinge Screw	545119 (853)	Frame Top Cover Screw
504048 (833)	Needle Bar Crank Shaft Bushing (front) Set Screw	545080 (803)	Feed (front) Bar Hinge Pin Set Screw	545119 (853)	Looper (right hand) and Spreader Lever Connection Cover Screw (2)
504048 (833)	Oil Gauge Window Plug Screw	545081 (803)	Feed (back) Connecting Link Hinge Screw	545119 (853)	Lifting Lever Bracket Screw (2)
504048 (833)	Oil Tube Joint Frame Plug Screw	545081 (803)	Feed (back) Regulator Hinge Screw	545120 (829)	Lifting Lever Hinge Screw
504054 (819)	Needle Bar Cover Lock Spring Screw (2)	545082 (803)	Feed (back) Regulator Set Screw	545121 (810)	Presser Lever Lifter Hinge Screw
504071 (833)	Oil Pump (centrifugal) Body Screw (3)	545083 (853)	Feed (back) Regulator Thumb Screw	545122 (853)	Lifting Lever Stop Screw (2)
504078 (803)	Frame Back Cover Bracket Screw (2)	545084 (853)	Thread (needle) Eyelet Screw	545123 (852)	Chip Guard Holder Thumb Screw
504095 (850)	Feed (front) Rock Shaft Hinge Pin Bushing (left) Set Screw	545084 (853)	Thread (looper, right hand) Staple Screw	545124 (850)	Balance Wheel Set Screw
504095 (850)	Feed (front) Rock Shaft Hinge Pin Bushing (right) Set Screw	545085 (829)	Needle Bar Thread Retainer Screw, for 546537 and 546538	545125 (850)	Balance Wheel Position Screw
504095 (850)	Frame Rotary Shaft Bushing (front) Set Screw	545086 (829)	Needle Bar Thread Retainer Bracket Screw	545127 (850)	Needle Bar Cover Hinge Screw (2)
504095 (850)	Frame Rotary Shaft Flanged Bushing (back) Set Screw	545088 (853)	Thread (needle) Eyelet Screw	545130 (810)	Frame Back Cover Thumb Screw
504095 (850)	Looper (right hand) and Spreader Lever Hinge Pin Bushing (back) Set Screw	545088 (853)	Thread (looper, right hand) Staple Screw	545131 (809)	Oil Tube Joint Bolt (large) (3)
504095 (850)	Looper (right hand) and Spreader Lever Hinge Pin Bushing (front) Set Screw	545091 (829)	Presser Regulating Thumb Screw	545132 (809)	Oil Tube Joint Bolt (small) (4)
504095 (850)	Looper (left hand) Lever Hinge Stud Set Screw	545092 (803)	Feed (front) Dog Screw	545134 (803)	Feed (back) Bar Hinge Screw
504130 (850)	Machine Base and Oil Reservoir Oil Drain Cap Screw	545093 (803)	Feed (back) Dog Screw	545161 (829)	Cloth Plate Hinge Screw
504134 (850)	Presser Lever Hinge Stud Set Screw	545094 (833)	Feed (front) Regulator Set Screw (2)	545177 (853)	Tension (needle thread) Thread Guide Screw, for 81U88
504136 (825)	Balance Wheel Oil Guard Screw (2)	545095 (803)	Feed (front) Rock Shaft Crank Clamping Screw	545179 (803)	Oil Flow Regulating Pin Clamp Screw
504136 (825)	Needle Bar Cover Bracket Screw (2)	545096 (803)	Feed (front) Regulator Connection Adjusting Screw	545180 (803)	Presser Foot Chaining-Off Finger Screw, for 546593 and 546601
504145 (810)	Frame Side Cover Screw (2)	545097 (803)	Feed (front) Regulating Screw Stud	545181 (803)	Presser Foot Plate Spring Adjusting Pin Set Screw, for 546593 and 546601
504159 (819)	Balance Wheel Cap Screw (3)	545098 (850)	Knife (movable) Lever Hinge Stud Set Screw	545406 (853)	Needle Clamping Nut, for 81U86
504159 (819)	Frame Rotary Shaft Cover Screw (5)	545099 (803)	Knife (movable) Lever Connection Cap Screw (2)	545407 (819)	Feed (front) Connecting Rod Hinge Screw Nut
504167 (805)	Arm Screw (2)	545100 (850)	Knife (movable) Holder Guide Plate Screw (2)	545407 (819)	Feed (front) Regulator Connection Hinge Screw Nut
504507 (809)	Thread Guide (looper, left hand) Lock Nut (2)			545407 (819)	Knife (movable) Lever Connection Hinge Screw Nut
				545407 (819)	Looper (left hand) Lever Connecting Link Hinge Screw Nut (2)
				545408 (803)	Feed (front) Regulating Screw Stud Nut
				545409 (819)	Knife (stationary) Holder Stop Screw Nut (2)
				545409 (821)	Lifting Lever Stop Screw Nut (2)

From the library of: www.needle.com

NUMERICAL LIST OF PARTS FOR MACHINES 81U86 AND 81U88

PART NO.	DESCRIPTION	PART NO.	DESCRIPTION	PART NO.	DESCRIPTION
546625	Frame Rotary Shaft Cover Gasket	546690	Oil Flow Check Valve Ball	546664	Oil (400 cc)
546626	Machine Base and Oil Reservoir	546691	Oil Flow Check Valve Ball Spring	546674	Spreader, for 81U86
546627	Machine Base and Oil Reservoir Gasket	546693	Feed (front) Bar Oil Pad	546689	Screw Driver (small)
546628	Oil Filter Screen (4)	546695	Frame Angle Cover (front)	546692	Screw Driver (medium)
546629	Oil Filter Screen Clamp (4)	546696	Frame Angle Cover (back)	547088	Threading Wire (2)
546630	Machine Base and Oil Reservoir Oil Drain Cap Screw Gasket	546697	Machine Base and Oil Reservoir Oil Cup	549130	Wood Screw No. 11×1 inch (4)
546631	Oil Gauge Window	546698	Looper (right hand) and Spreader Lever Connection Cover Screw Washer (2)		
546632	Oil Gauge Window Gasket	546699	Needle Bar Connecting Link Hinge Pin Oil Wick (2)		
546633	Oil Pump (centrifugal) Body	546701	Machine Base and Oil Reservoir Oil Cup Gasket (2)		
546634	Oil Pump (centrifugal) Body Gasket	546705	Feed (back) Bar	546663	Foot Lifter Treadle, complete
546635	Oil Pump (centrifugal) Impeller Shaft	546706	Feed (back) Connecting Link	546660	Foot Lifter Chain
546637	Oil Pump (centrifugal) Impeller Shaft Gear	546707	Needle Bar Thread Retainer Bracket, for 546537		
546638	Feed (front) Eccentric and Gear with two 504007	546708	Needle Bar Thread Retainer Bracket, for 546538		
546639	Oil Tube Joint Frame	546709	Knife (movable) Holder Cap		
546640	Oil Tube Joint Frame Gasket	546710	Knife (movable) Holder Screw Extension Pin	546703	Thread Unwinder complete (for 4 spools), for 81U88
546641	Oil Focal Point (large)	546711	Presser Foot Chaining-off Finger, for 546593	546704	Thread Unwinder complete (for 3 spools), for 81U86
546642	Oil Focal Point (small)	546712	Presser Foot Plate Spring Adjusting Pin, for 546593 and 546601		
546643-001	Oil Tube Joint (single way) (3)	546713	Presser Foot Plate Spring, for 546593 and 546601		
546643-002	Oil Tube Joint (single way) Suction End	546714	Presser Foot Chaining-off Finger, for 546601		
546644	Oil Tube Joint (two way) (2)	546715	Frame Side Cover Hinge Pin	546746	Knee Lifter, complete
546645-001	Oil Tube (vinyl)	546716	Frame Side Cover Hinge Pin Spring		
546645-002	Oil Tube (vinyl)	546717	Machine Base Cushion (2)		
546645-003	Oil Tube (vinyl)	546719	Balance Wheel Oil Guard		
546645-004	Oil Tube (vinyl)	546720	Balance Wheel with 545124, 545125 and three 504159		
546646	Oil Focal Point Oil Wick (7)	546721	Feed (back) Dog, for 81U88	546724	Throat Plate, for 81U86
546647	Oil Tube Joint Washer (16)	549045 (803)	Knife (movable) Holder Cap Screw (2)	546725	Feed dog, for 81U86
546648	Oil Tube Clamp (8)	549046 (803)	Knife (movable) Holder Screw	546726	Presser Foot complete, Nos. 545180, 545181, 546711, 546712 and 546713, for 81U86
546649	Oil Tube Holder (large)	549049 (833)	Frame Rotary Shaft Crank Set Screw		
546650	Oil Tube Holder (small) (2)	549072 (805)	Machine Base Cushion Screw (4)		
546656	Looper (left hand) Lever Hinge Stud Oil Wick	549084 (833)	Needle Bar Crank (back) Position Screw		
546657	Feed (front) Regulating Screw Stud Nut Washer	549084 (833)	Needle Bar Crank (front) Position Screw		
546658	Feed (front) Bar Hinge Pin Collar with 154790	549085 (833)	Needle Bar Crank (back) Set Screw		
546659	Chip Guard Holder Thumb Screw Washer	549085 (833)	Needle Bar Crank (front) Set Screw		
546671	Oil Flow Regulating Pin O-Ring	549437	Looper (right hand) and Spreader Lever Connection with four 545077	546724	Throat Plate, for 81U86
546672	Oil Flow Regulating Pin			546725	Feed dog, for 81U86
546675	Looper (right hand) and Spreader Lever Connection Cover Gasket			546742	Presser Foot complete, Nos. 545180, 545181, 546712, 546713 and 546743, for 81U86
546676	Oil Tube Joint Washer			546743	Presser Foot Chaining-off Finger
546680	Thread Guide (looper, left hand) (2)				
546681	Looper (right hand) and Spreader Lever Ball Stud Oil Wick				
546681	Needle Bar Crank (back) Ball Stud Oil Wick				
546682	Needle Bar Connecting Rod Oil Wick				
546683	Frame Rotary Shaft Oil Wick				
546684	Oil Pump (centrifugal) Impeller Shaft Oil Wick				
546685	Looper (right hand) and Spreader Lever Hinge Pin Oil Wick				
546686	Feed (front) Rock Shaft Hinge Pin Oil Wick				
546688	Tension (looper, left hand) Spring				
546688	Tension (looper, right hand) Spring, for 81U86				

FOOT LIFTER

(Supplied with machine)

THREAD UNWINDER

(Supplied with machine)

KNEE LIFTER

(Will be supplied in place of Foot Lifter if specified on order)

FOR LIGHT AND MEDIUM WEIGHT FABRICS AND KNIT GOODS

(Supplied only when specified on order)

FOR MEDIUM AND HEAVY SWEATER MATERIALS

(Supplied only when specified on order)

ACCESSORIES

- Oiler
- Needle (81×1) #11 (10)
- Wood Screw No. 11×1 inch (2)
- Tweezers (curved)
- Wrench
- Screw Driver (large)
- Welt Guide complete, for 81U86
- Machine Cover

NUMERICAL LIST OF PARTS FOR MACHINES 81U86 AND 81U88

PART NO.	DESCRIPTION	PART NO.	DESCRIPTION	PART NO.	DESCRIPTION
545409 (821)	Presser Lever Screw Stud Nut	546537	Needle Bar Thread Retainer complete, Nos. 545085, 546540, 546707 and two 546539, for 81U86	546571	Needle Guard
545409 (821)	Tension (needle thread) Screw Stud Nut (2), for 81U88			546572	Looper (right hand) and Spreader Lever
545411 (805)	Cloth Plate Hinge Screw Nut	546538	Needle Bar Thread Retainer complete, Nos. 545085, 546540, 546708 and two 546539, for 81U88	546573	Looper (right hand) and Spreader Lever Hinge Pin
545414 (853)	Knife (stationary) Clamping Stud Thumb Nut			546574	Thread (looper, left hand) Eyelet
545855	Oil Pump (centrifugal) Cover	546539	Needle Bar Thread Retainer Disc (2), for 546537 and 546538	546576	Looper (right hand), for 81U86
545856	Oil Pump (centrifugal) Impeller			546577	Looper (right hand), for 81U88
545857	Oil Pump (centrifugal) Screen	546540	Needle Bar Thread Retainer Spring, for 546537 and 546538	546578	Looper (left hand) Lever
545858	Oil Pump (centrifugal) Screen Frame			546579	Looper (left hand) Lever Hinge Stud
546503	Arm Dowel Pin (2)	546541	Needle Bar Crank (back) with 545108, 549084 and 549085	546580	Thread (looper, right hand) Take-up, for 81U86
546504	Needle Bar Crank Shaft			546581	Looper (left hand)
546505	Needle Bar Crank Shaft Oil Wick	546542	Looper (right hand) and Spreader Lever Ball Stud	546582	Looper (left hand) Lever Connecting Link
546506	Needle Bar Crank Shaft Bushing (front)	546542	Needle Bar Crank (back) Ball Stud	546584	Thread (looper, right hand) Staple
546507	Needle Bar Crank Shaft Bushing (back)	546543	Needle Bar Connecting Rod with four 545077	546585	Tension (looper, right hand) Thread Guide
546508	Needle Bar Crank (front) with 549084 and 549085	546544	Looper (right hand) and Spreader Lever Connection Guide	546586	Tension (looper, left hand) Screw Stud
546509	Thread (needle) Take-up	546544	Needle Bar Connecting Rod Guide	546586	Tension (looper, right hand) Screw Stud
546510	Needle Bar with two 545070, for 81U88	546545	Frame Rotary Shaft Flanged Bushing (back)	546586	Tension (needle thread) Screw Stud (2), for 81U88
546511	Needle Bar with 545406, for 81U86	546546	Frame Rotary Shaft Bushing (front)	546587	Tension (looper, left hand) Thread Guide
546512	Needle Bar Connecting Bracket with 545071	546547-001	Oil Pad, for Feed Front Rock Shaft	546589	Throat Plate, for 81U86
546513-001	Needle Bar Bushing (lower)	546547-002	Oil Pad, for Frame Rotary Shaft Flanged Bushing (2)	546590	Thread (looper, left hand) Tube Presser Lever
546513-002	Needle Bar Bushing (upper)	546547-003	Oil Pad, for Frame Rotary Shaft Bushing (front)	546592	Presser Lever Hinge Stud
546514	Needle Bar Connecting Link	546548-001	Feed (front) Rock Shaft Hinge Pin Bushing (left)	546593	Presser Foot complete, Nos. 545180, 545181, 546711, 546712 and 546713, for 81U86
546515	Needle Bar Connecting Link Hinge Pin (2)	546548-001	Looper (right hand) and Spreader Lever Hinge Pin Bushing (front)	546594	Presser Foot Screw Washer
546517	Frame Screw Washer (4)	546548-002	Feed (front) Rock Shaft Hinge Pin Bushing (right)	546595	Lifting Lever Bracket
546518	Frame Rotary Shaft	546548-002	Looper (right hand) and Spreader Lever Hinge Pin Bushing (back)	546596	Lifting Lever Spring
546519	Feed (front) Lifting Eccentric Connection	546550	Presser Lever Spring	546597	Presser Lever Lifter
546520	Feed (front) Lifting Eccentric with two 504048	546551	Feed (back) Regulator	546598	Tension (needle thread) Thread Guide, for 81U88
546521	Frame Rotary Shaft Crank with 545076, 546522 and 549049	546552	Feed (front) Dog	546599	Thread (looper, right hand) Take-up, for 81U88
546522	Frame Rotary Shaft Crank Oil Pad (felt)	546554	Feed (back) Dog, for 81U86	546600	Throat Plate, for 81U88
546524	Feed (front) Connecting Rod with two 545078	546555	Feed (front) Regulator Hinge Stud	546601	Presser Foot complete, Nos. 545180, 545181, 546712, 546713 and 546714, for 81U88
546525	Feed (front) Bar	546556	Feed (front) Regulator with two 545094	546602	Lifting Lever with two 545122 and 545409
546527	Feed (front) Rock Shaft	546557	Feed (front) Rock Shaft Crank with 545095	546603	Chip Guard Holder
546528	Feed (front) Rock Shaft Hinge Pin	546558	Feed (front) Regulator Connection with 545096	546606	Chip Guard
546529	Feed (front) Bar Hinge Pin	546559	Knife (movable) Lever	546608	Needle Bar Cover
546530	Thread (needle) Eyelet, for 81U86	546560	Knife (movable) Lever Hinge Stud	546609	Needle Bar Cover Bracket
546531	Thread (needle) Eyelet, for 81U88	546561	Knife (movable) Lever Connection with two 545099	546610	Needle Bar Cover Lock Spring
546532	Tension (needle thread) Thread Guide, for 81U86	546562	Knife (movable) Holder Guide Plate	546611	Frame Top Cover
546533	Tension (looper, right hand) Spring, for 81U88	546563	Knife (movable) Holder Guide with 545101	546612	Frame Side Cover complete, Nos. 546715 and 546716
546533	Tension (needle thread) Spring, for 81U86	546564	Knife (movable) Holder	546616	Looper (right hand) and Spreader Lever Connection Cover
546533	Tension (needle thread) Spring (2), for 81U88	546565	Knife (movable) Gib	546617	Cloth Plate, complete
546535 (821)	Tension (looper, left hand) Regulating Thumb Nut	546566	Knife (movable) Holder Spring	546619	Frame Back Cover
546535 (821)	Tension (looper, right hand) Regulating Thumb Nut	546567	Knife (movable)	546620	Frame Back Cover Bracket (2)
546535 (821)	Tension (needle thread) Regulating Thumb Nut, for 81U86	546568	Knife (stationary) Holder with two 545103 and 545409	546621	Frame Back Cover Hinge Pin
546535 (821)	Tension (needle thread) Regulating Thumb Nut (2), for 81U88	546570	Knife (stationary) with Stud	546622	Frame Back Cover Lock Spring
546536	Tension (needle thread) Screw Stud, for 81U86			546623	Frame Back Cover Hinge Pin Washer (2)
				546624	Frame Rotary Shaft Cover, complete

From the library of Diamond Needle Co.